

User's Manual

BT49QT-9

BT49QT-3

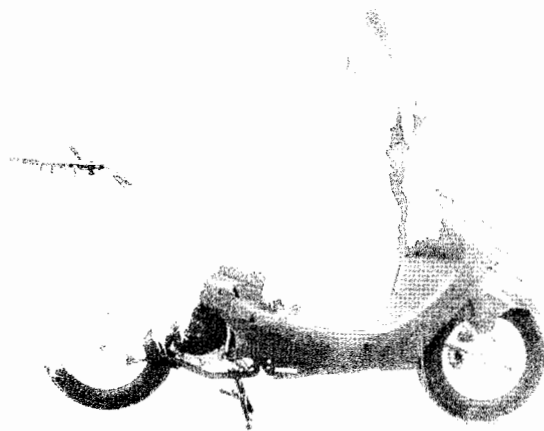

Preface

Thank you very much for purchasing 'BAOTIAN' brand motorcycle of model BT49QT-9 or BT49QT-3 developed by **JANGMEN BAO TIAN MOTORCYCLE INDUSTRIAL CO., LTD.** And welcome to join the driver's line if BAOTIAN motorcycle.

With its extraordinary advantages of excellent quality, smart appearance and shape of legerity, our product will surely bring the utmost pleasure and convenience to your life.

This manual gives you information about the general structure, function, operation and maintenance methods of BT49QT-9 & BT49QT-3. In order to enable your beloved motorcycle to render a best performance and a longer life, please read this manual carefully, pay particular attention to the running-in part in it and follow all the operating instruction. It is of great importance to make your riding safer and more comfortable. Experienced staffs in our sale agency and the maintenance shop will also offer excellent service for you.

- Please take an initial examination of your motorcycle after the first 300km running in our designated maintenance shop, and take regular examination in every 1000km thereafter.
- All the direction, illustration and specification included in this manual are based on the latest product information. Please be noted that they may be different from the actual status of the motorcycle if there is new revision on its specification, and no further advice will be given.

CONTENTS

Guidance	2
Names of parts	4
Controlling parts	5
Starting lever	7
Fuel tank	7
Fuel and machine oil	7
Pre-riding inspection	8
Engine starting	9
Running-in	9
Regular maintenance	11
Tools	15
Technical Parameters	16
Electrical Circuit Chart	18

Guidance

Please keep safety in your mind and observe the regulations of transportation while enjoying your riding. Pay attention to the following rules:

1. Pre-riding inspection

Please read the details in the relevant chapter for your safety

2. Helmet

Do remember to wear helmet while riding.

3. Being familiar with motorcycle operation

It is of great importance to ensure your safety getting familiar with motorcycle operation.

4. Speed limitation

Drive at proper speed in accordance with the road condition, the weather and your driving skill.

5. Position of the label

WARNING
It is dangerous to drive on the wet road. Do not make an abrupt turning while accelerating and keep proper distance from other vehicles.

6. Positions of the numbers

The frame number and the engine number are for the purpose of registering the motorcycle. When your motorcycle needs inspection, repair or other special service, the number will enable you to get good service from our sale agency. Please note down your number here:

The frame number: _____

The engine number: _____

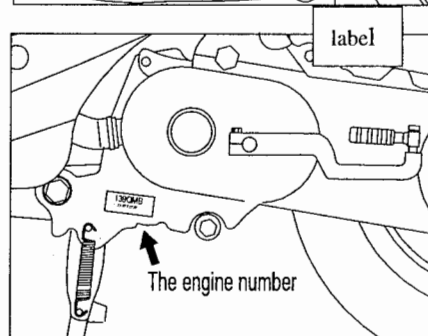
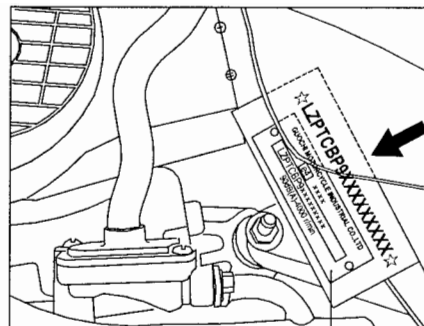

□ Names of parts

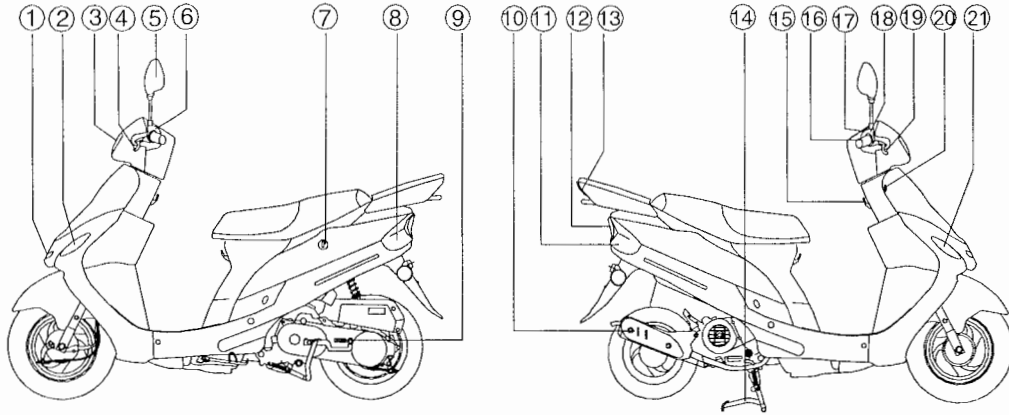

- (1) Front signal light
- (2) Left front turning light
- (3) Head light
- (4) Rear brake lever
- (5) Rear-view mirrors
- (6) left switches
- (19) Front brake lever

- (7) Seat lock
- (8) Left rear turning light
- (9) Starting pedal
- (10) Muffler
- (11) Right rear turning light
- (12) Rear light
- (20) Ignition switch

- (13) Rear signal light
- (14) stand
- (15) Helmet hook
- (16) Throttle control lever
- (17) Meters
- (18) light switches
- (21) Right front turning light

□ Controlling parts

1. Rear brake lever

Hold it tight and the rear brake functions

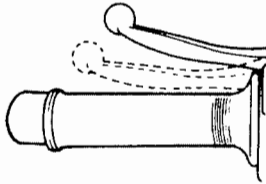

2. Switches on the left handle

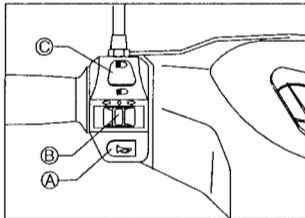

A. Turning signal switch

← Left turning light

→ right turning light

B. Horn button

C. Switch for high/low beam lights

3. Meters and indicating lights

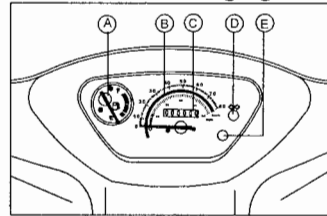

A. Fuel gauge.

B. Speedometer indicates the speed in km/ hour

Odometer indicates the total distance the motor-

C. cycle has run.

D. Turning lights indicator

E. High beam indicator

4. Front brake lever

Press it tightly and the front brake functions.

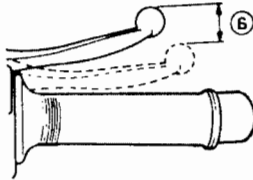

5. Switches on the right handle

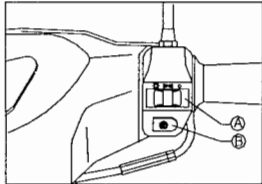

A. Head light switch

B. Ignition button

When the ignition switch is at ON position, hold the brake and push the button, and then the engine works

Warning:

- ◆ 5 seconds is the maximum limit for each starting and 10 second is the minimum interval.
- ◆ Stop pressing the starting button immediately after the engine starts.
- ◆ Do not press the starting button while the engine is running, or the start motor will be damaged.

6. Ignition switch

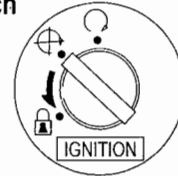

OFF The whole circuit is cut. Engine and lights cannot be operated and the key can be withdrawn.

ON Engine cannot be started and all the lights can be operated. The key cannot be withdrawn.

LOCK Turn the steering handle fully to the left, slightly press the key and turn it to the position lock. Then the key can be taken out.

Starting lever

Starting lever is for kicking start of the engine.

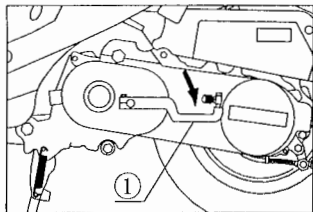

Fuel tank

Usage of the cap:

1. Insert the key.
2. Turn it clockwise and take off the cap.
3. Fix the notch and then press the cap on.

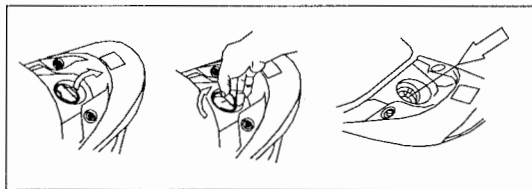

Warning:

- ◆ Turn off the engine when refilling the tank.
- ◆ Turn off the cap slowly.
- ◆ Align the mark "△" on the cap to the , mark"  on the tank.
- ◆ Don't overfill the gasoline over the designated scale
- ◆ Do not add anything into the gasoline.

Fuel and engine oil

A. Gasoline

High-quality fuel is essential to the engine.
Any sand in the fuel is absolutely prohibited.
90# gasoline and unleaded gasoline is preferred.

B. Engine oil

SAE-15W/40#

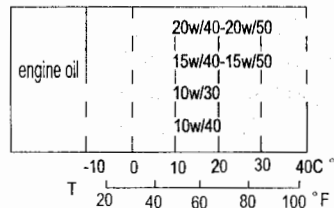

Pre-riding inspection

Please check the following parts before you drive.

No.	Items	Inspection content
1	Steering bar	1.Flexibility 2.No gap or loosing appearance
2	Brake system	1.Interval between front brake and rear brake 2.No break on the cable 3.Flexible function
3	Tires	1.Proper pressure 2.No crack or cutting
4	Fuel	Sufficient fuel
5	Engine oil	Sufficient engine oil
6	Lights	Workable
7	Horn	Workable
8	Gear oil	With normal stock
9	Throttle	1. Proper gap 2.Flexible function 3.Proper control lever returning
10	All the bolts and nuts	No loosing appearance.

□ Engine starting

1. Please check the volume of machine oil and gasoline before starting. The main stand should be stood up while starting the engine.
2. Turn the ignition switch to the "ON" position.

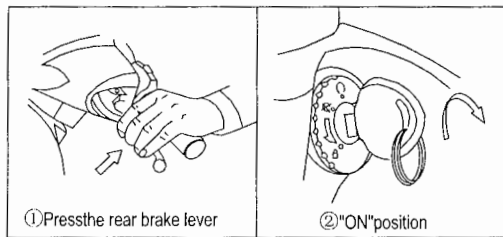

Warning

- ◆ Press the rear brake lever in case that the motorcycle rushes forwards abruptly.

3. Engine Starting

Push the starting button and then the engine starts.

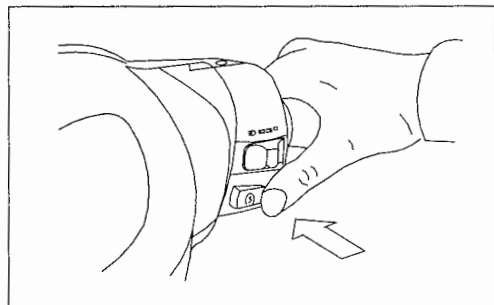

Warning :

- ◆ 5 seconds is the maximum limit for each starting and 10 seconds is the minimum interval.
- ◆ Stop pressing the starting button immediately after the engine starts.
- ◆ Do not press the starting button while the engine is running, or the start motor will be damaged.
- ◆ When using electric starting, please press the rear brake lever in advance to get through the circuit and start the motor.
- ◆ When using electric starting, don't operate the starting motor continually, or it may cause damage to the starting motor and the battery.
- ◆ Warm up the engine after cold starting, (about 3

4. Kick Starting

Press the brake handle, tread the starting grip heavily and then the engine will start.

Warning

- ◆ After the engine starts, the starting grip should be turned to its original position. Otherwise, it will affect the driver's safety.
- ◆ Please don't start the engine in malventilated places because the wasted gas with CO is harmful to human beings

Running in (BT49QT-9)

To maintain your motorcycle running in a good condition, please follow the below rules during the new running-in period.

Distance(km)	Speed limitation (km/h)
0-200	25
200-1000	35
1000-----	≤45

Regular maintenance

Item	Interval	300	1000	3000	6000	12000
	Km Month	New motor	1	3	6	12
Battery		I	I	I	I	I
Nuts on tank cap and exhausting tub*		I	F	F	f	F
Cylinder cap, cylinder and muffler*		--	C	C	C	C
Carburetor		I	I	--	--	I
Air cleaner		Clean it between every 2000km				
Spark plug		I	--	I		
Fuel line		Replace every four years				
Clutch *		--	--	--	I	I
V-strap		--	--	--	I	I
Engine oil		R	R	Replace every 3000km		
Brake *		I	I	I	I	I
Front fork and steering *		I	I	--	I	I
Rear suspension		I	I	--	I	I
Tires		I	I	I	I	I
Fastening nuts and bolts		I	F	--	F	F
Gear oil		R	Replace every 5000km / 5Month			
Start motor		--	--	--	--	I

NOTE: I=Inspect and clean, adjust, replace or lubricate as necessary. C=Clear, R=Replace, F=fastened

Service more frequently when riding in dusty areas.

1. Battery

12V/4Ah battery

- ① When the voltage is less than 11.5V, please use kicking start in stead of electric starting
- ② Place the ignition switch to **OFF** position before battery replacement.
- ③ Electrode identification: "+"—red line, "-"—black line.
- ④ Change a new battery every 4 years.

2. Carburetor and idle speed adjustment

- ① Keep the engine warmed up for 2-3 minutes.
- ② Adjust the lidling speed screw to set the engine at speed If abort 1800 rpm. The idle speed adjusting screw.

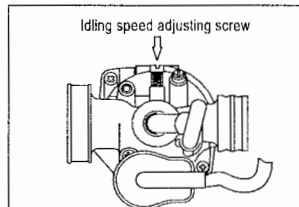

Warning:

- ◆ It has been fully adjusted to the highest position when manufactured.

3. Air cleaner

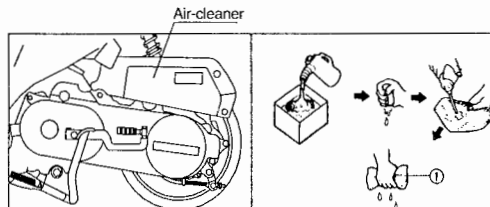

- ① Pour the non-inflammable detergent into a basin and immerse the core of air cleaner Into the detergent for cleaning.

- ② Press the core to squeeze the detergent out of it by the palms. Never twist it in case that it is broken.
- ③ Immerse the core into engine oil.
- ④ Squeeze the excessive oil out if it but keep it lightly oil immersed.

4. Spark plug

- ◆ Clean the carbon deposit on the spark plug with a piece of hard wire or steel needle.
- ◆ Adjust the gap to 0.6-0.7mm with a thickness gauge.
- ◆ Use (NGK) C7HSA when replacement is needed.

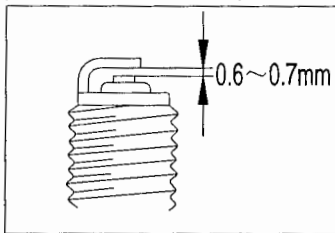

5.Fuel

Refill the recommended unleaded gasoline with an octane number of 90# or higher when the indicating needle points to the red area in the fuel gauge.

NOTE: *Unleaded gasoline will extend spark plug and catalytic converter life.*

6.Engine oil

Replace the engine oil with the engine warmed up.

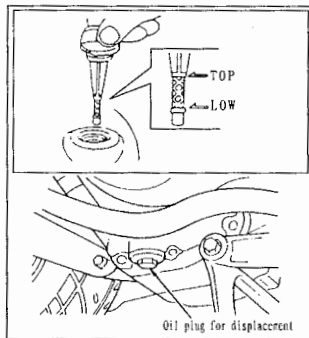

- ① Remove the oil dipstick.
- ② Remove the oil plug to drain the used oil.
- ③ Reinstall the oil plug, paying attention to the tightness.
- ④ Refill 0.8 L recommended flesh oil
- ⑤ Fasten all the nuts and screws.

7.Brake system

Normal free stroke of the brake lever is about 10-20mm.

- ①The front brake

Turn the adjusting nut to get a proper stroke

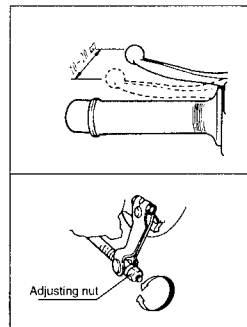
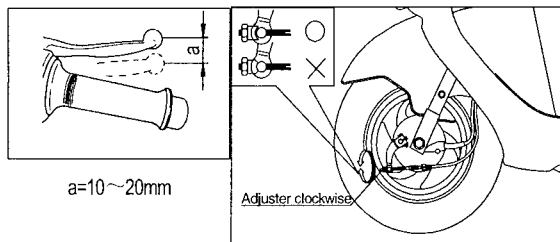

- ②The rear brake

Turn the adjusting nut to get a proper stroke.

Warning:

- ◆ FREE STROKE means the distance between the positions from free status to the beginning performance of the brake.
- ◆ Pay attention to the sensitivity of the brake.

☆☆Front brake(Disk brake) ☆☆

◆Grip the brake handle and check the wear & tear indicator .If the wear and tear indicator. If the indicator nearly touched the brake disk, please ask the appointed maintainer to change the brake shoes

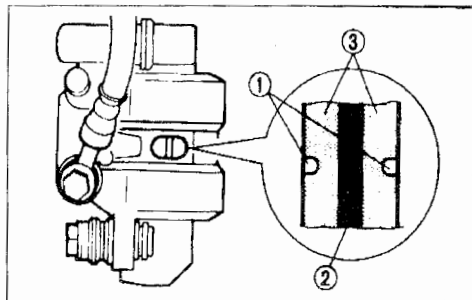

①wear & tear indicator ②Brake disk ③Brake shoes

◆Check the following items of brake system before driving the motorcycle:

- ① Check if there is any leakage ;
- ② Check if there is any leakage or crack on the oil pressed hose;

- ③ The brake handlebar should be kept with a certain free swing distance from 10~20mm, and kept a certain re- grip power;
- ④ Abrasion situation of the brake shoes.

◆ Brake oil level

① It has been filled the special brake oil before the motorcycle leaves the factory. User should fill or change the qualified brake oil (such as No.DOT3 & DOT4

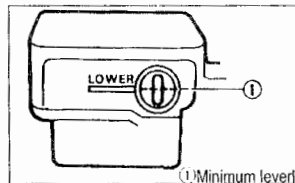

brake oil) from the appointed maintenance station .Never change or mix other oil, otherwise it would damage the brake system.

②If the brake oil is insufficient, it might be possible for the air to come into the brake system, and result in the failure of the system

Warning

Brake oil is corrosive material .It would damage and corrupt the painting of the part . It should be cleanout if the oil splash on the part .If the oil sprayed on the skin or eyes ,it should be cleaning quickly with a lot of water.

8. Tires

Insufficient tire pressure hastens wear of them and affects the riding stability. Please check the tire pressure and tread depth when applying regular maintenance.

- ① Tire pressure: front 200 kpa rear 225 kpa.
- ② Tread depth: It is suggested to replace a new tire when the tread depth is less than 1 mm.

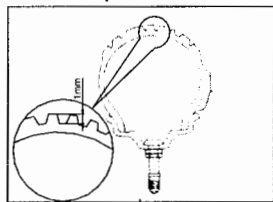

Warning:

- ◆ The standard tire is 3.0-10-42J for front and rear. The use of tire other than standard may cause trouble.
- ◆ Tire inflation pressures and the general tire condition are extremely important to the proper performance and safety of the vehicle.

9. Starting motor

Check the fastening bolts and the carbon brush, and replace them if necessary.

10. Fuse

Fuse is linked with the outer line of the battery. When a light or circuit fails suddenly, check the fuse first.

Warning:

- ◆ The fuse cannot be replaced by any iron or aluminum wire.

11. Gear oil

Please use the recommended gear oil: SAE 40#

Tools

A full set of tools is offered for your daily use.

Technical Parameters

	Items	Specifications
Size	Length Width Height Wheel base Min. distance above ground	1660mm 680mm 1070mm 1195mm 80mm
Weight	Unloaded weight Loaded weight Mass weight	85kg 75kg / 150 kg (including the driver) 165kg / 235kg(for two people)
Capacity	Max. Speed Min. Speed Slope Turning Conner Dia. Of turning Conner	45km/h (e-mark) or 60 km/h $\leq 1.8\text{km/h}$ $\geq 6^\circ$ $\geq 45^\circ$ $\leq 3200\text{mm}$
Circuit system	Spark plug Battery Fuse Headlight Tuning lights Brake light Indicating lights	(NGK)C7HSA 12V/4AH 10A 12V 35W 12V 10W 12V 21W/8W 12V 5W

Regular maintenance

Volume of the fuel tank		6.5L
Volume of the engine oil tank		1L
Engine	Model	BT139QMB
	Type	1 cylinder, cooled by forced air,
	Cylinder	4 stroke
	Bore and stroke	1
	Cylinder volume	39*41.5mm
	Compression ratio	49.5ml
	Max. power	10.5:1
	Max. torque	2.2 kW /7500(r/min)
	Carburetor	2.7 kN /7000(r/min)
	Air cleaner	PZ18J
	Ignition type	Polyurethane plastic core
	Starting mode	CDI
	Cooling mode	Electric/kicking start
Lubrication	Forced air-cooled	
Frame		Pressure/splash
Suspension	Front absorber	Steel tube frame
	Rear cushion	Rock-arm variable-pitch spring & hydraulic damping shock absorber
Brake system		Single damping shock absorber
Tires		Variable-pitch spring & hydraulic damping shock absorber
		Expansion braking shoe
		3.00-10 42J

Technical Parameters

